

item	NAME
1	Suction Silencer
2	Moter
3	Roots Blower
4	Relief Valve
5	Pressure Gauge
6	cut-off valve
7	Guard
8	Pedestal
9	Discharge Silencer
10	Flexible Joint

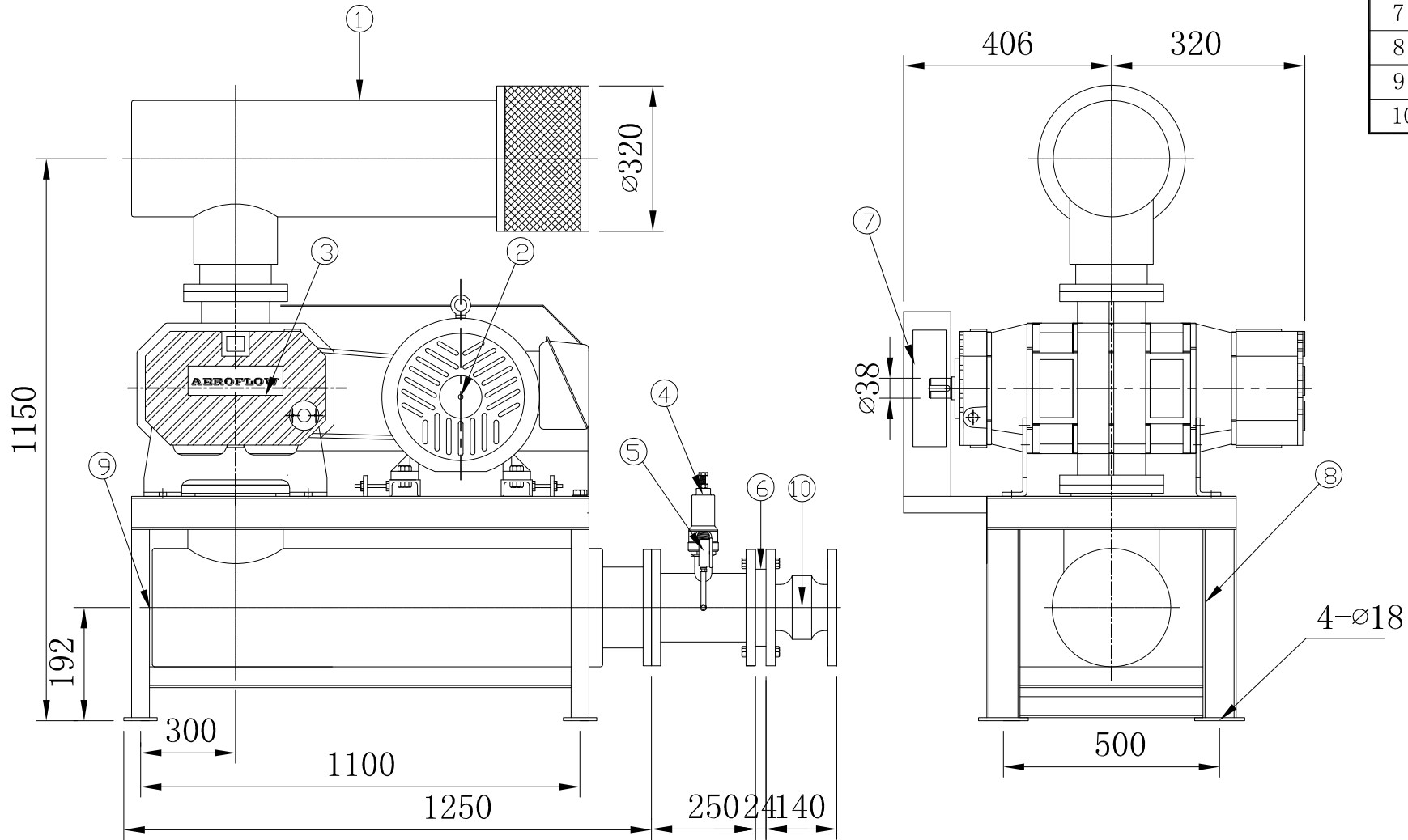

HEY-WEL
MACHINERY CO., LTD.

Drawing Name		Type NO.	Drawing NO.		Material	Unit	Scale	Drew	Date
Outline Drawing		EV-125	C512-A0		Assembly	mm	A4 1/16	koko	08. 12. 04
Revision	Description	Revision	Description		Revise	Check	Approved	Projection	
									⊕